



LINE SEIKI

Product Catalog

2014 Ver.1



DK-100H



E48 Series



CT1 Series



TM7 Series

- Electronic Counter
- Electromagnetic Counter
- Mechanical Counter
- Length Measuring Counter
- Pulse Generator
- Rotary Encoder
- Tachometer
- Thermometer
- Measuring Instruments
- Tally Counter

G95 / G90 Series

■ Company Overview

"As long as humans live counting will be a necessity." ~ Line Seiki

Human progress and development over the years has been measured by numbers. Statistics are as vital to the ordinary student or hobbyist as they are to experienced professionals. For 60 years now, Line Seiki has served this everyday need to count, measure, track, and monitor various activities through its wide variety of industrial counters, measuring instruments, and sensors.



From its humble beginnings as a counter maker in post-World War II Japan, Line Seiki has grown to become a global leader in industrial, professional, and even personal counter-serving the needs of markets across the Asia Pacific, Europe, and the Americas. As a pioneer in counting technology, it has perfected the science and art of measurements while keeping up with the latest counting technology. Wherever you will see humans and their need to count and measure, you will see Line Seiki.

Now with five locations throughout the Asia Pacific and a vast network of distributors globally, Line Seiki manufactures and supplies product models for just about every field or industry. Our products include the most advanced electronic, electro-mechanical and mechanical counters, tachometers, digital thermometers, tally counters, sensors, and encoders as well as other customized products. Applications range from factory automation to speed and time measurements for hobbyists, to everyday household uses. Moreover, many of our products are commonly used in original machine manufacture (OEM), including those found in vending machines, gaming machines, textile machines, plastic injection machines, metal stamping machines, and so on.

Our core business, above all, is product development. We fuse decades of experience with the latest advances in technology to engage in technological cooperation and joint product development with other world leaders in the field of counting. So as long as humans live, so will Line Seiki.

■ Line Seiki Group

- Line Seiki Co., Ltd. (Japan)
- Line Seiki Philippines Inc. (Philippines)
- Line Seiki Asia Pacific, Inc. (Philippines)
- LS Instrumentation Sales & Services (Philippines)
- Taiwan Line Seiki Co., Ltd. (Taiwan)
- Korea Line Seiki Co., Ltd. (Korea)

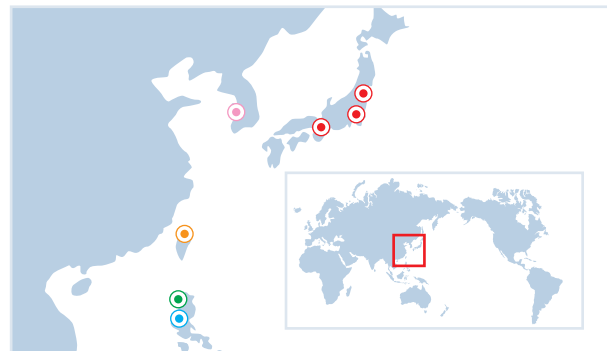

■ History

History	
Feb, 1949.	A trading company handling measuring tools was inaugurated in Tokyo, Japan.
Apr, 1954.	Line Seiki Co., Ltd. was incorporated in Tokyo, Japan.
May, 1985.	Shirakawa factory was established in Fukushima-Ken, Japan.
Jun, 1988.	Korea Line Seiki was established in Seoul, Korea.
Jun, 1988.	Taiwan Line Seiki was established in Taipei, Taiwan.
Aug, 1995.	Line Seiki Philippines, Inc. was established in Cavite, the Philippines.
Jun, 1999.	Line Seiki Asia Pacific, Inc. was established in the Philippines.
Jul, 2008.	LS Instrumentation Sales & Services was established in Quezon City, the Philippines.

MODELS

GR2 - □□□0

Type	Wiring	0:Terminal Screw
C:Totalizer	Input	0:Dry Contact / Open Collector / Voltage (NPN Transistor) Input 1:Wide Range Voltage Input
H:Hourmeter	Reset	0:Remote 1:Remote & Front
M:Minutemeter		
S:Secondmeter		



SPECIFICATIONS

Type	GR2-C:Totalizer	GR2-H:Hourmeter	GR2-M:Minutemeter	GR2-S:Secondmeter
Display	7segment LCD 7digits 8mm (H)			
No. of Digits	0 - 9999999	0.0 - 999999.9		
Spec of Input	Max.Count Speed GR2-C□□00 30Hz GR2-C□□10 20Hz	Resolution 1 Count per 1/10 Hour	Resolution 1count per 1/10 minute	Resolution 1count per 1/10 second

MECHANICAL / ENVIRONMENTAL SPECIFICATIONS

Ambient Temp. : Operating	-10 - +55°C (Should not be frozen)
Ambient Temp. : Storage	-20 - +65°C (Should not be frozen)
Ambient Humidity: Operating	25 - 85%RH (Non-Condensing)
Vibration / Shock Resistance	Malfunction : Single Amplitude 0.35mm Frequency 10 - 55Hz X.Y.Z. Axis 100mm/s ² Destruction : Single Amplitude 0.75mm Frequency 10 - 55Hz X.Y.Z. Axis 300mm/s ²
Protection of Front Panel	IP54
Weight	Approx. 50g (Battery Included)
Wiring	M3 Terminal Screw

ELECTRICAL SPECIFICATIONS

Input	Dry Contact / Open Collector / Voltage (NPN Transistor) Wide Range Voltage	L:<0.8VDC H:2 - 30VDC L:0 - 5VDC/AC H:20 - 250VDC/AC	Sink Current : 8 μA Input Impedance : 300kΩ * 50/60 Hz Convertible
Reset	Front Reset Remote Reset Dry Contact / Open Collector / Voltage (NPN Transistor) Wide Range Voltage	L:<0.8VDC H:2 - 30VDC L:0 - 5VDC/AC H:20 - 250VDC/AC	Sink Current : 8 μA Input Impedance : 300kΩ * 50/60 Hz Convertible
Reset Pulse Width	6ms MIN.		
Power Source	3.6V 1/2AA Lithium Battery (replaceable), 7 years min. with continuous input at 25°C *The battery life is not a guaranteed value.		
Compliance	CE, RoHS, UL		

DIMENSIONS : mm

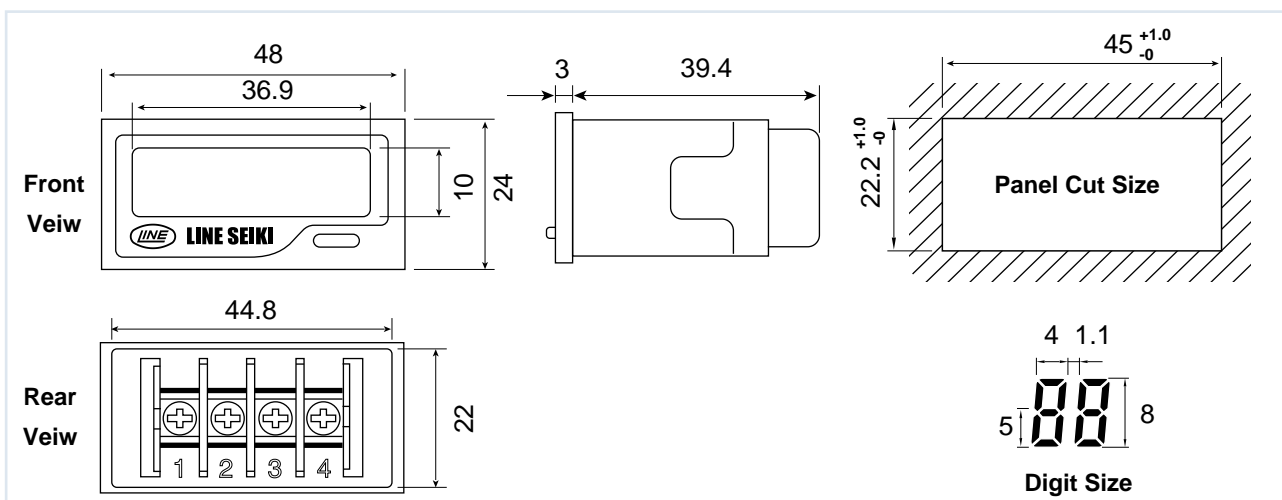

MODELS

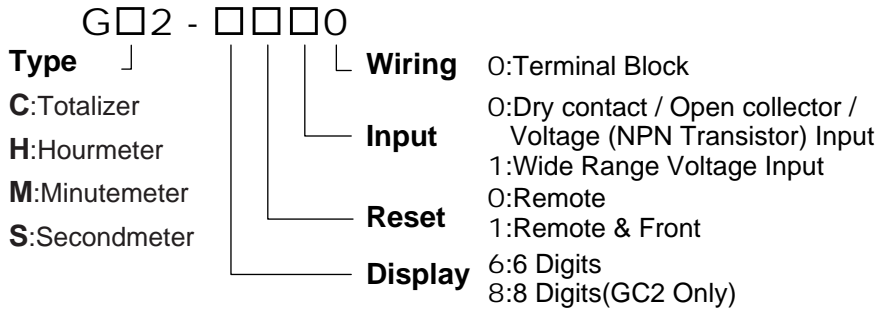

SPECIFICATIONS

Type	GC2: Totalizer	GH2: Hourmeter	GH2: Minutemeter	GH2: Secondmeter
Display	7segment LCD 6 / 8 (GC2 Only) digits 10.6mm (H)			
No. of Digits	0 - 999999 / 0 - 99999999		0.0 - 99999.9	
Spec of Input	Max.Count Speed G□2-□□00 30Hz G□2-□□10 20Hz	Resolution 1 Count per 1/10 Hour	Resolution 1count per 1/10 minute	Resolution 1count per 1/10 second

MECHANICAL / ENVIRONMENTAL SPECIFICATIONS

Ambient Temp. : Operating	-10 - +55°C (Should not be frozen)
Ambient Temp. : Storage	-20 - +65°C (Should not be frozen)
Ambient Humidity: Operating	25 - 85%RH (Non-Condensing)
Vibration / Shock Resistance	Malfuction : Single Amplitude 0.35mm Frequency 10 - 55Hz X.Y.Z. Axis 100mm/s ² Destruction : Single Amplitude 0.75mm Frequency 10 - 55Hz X.Y.Z. Axis 300mm/s ²
Protection of Front Panel	IP54
Weight	Approx. 60g (Battery Included)
Wiring	Terminal type:14-22 AWG lead wires to be connected by screws.

ELECTRICAL SPECIFICATIONS

Input	Dry Contact / Open Collector / Voltage (NPN Transistor) Wide Range Voltage	L:<0.8VDC H:2 - 30VDC L:0 - 5VDC/AC H:20 - 250VDC/AC	Sink Current : 8μA Input Impedance : 300kΩ * 50/60 Hz Convertible
Reset	Front Reset Remote Reset Dry Contact / Open Collector / Voltage (NPN Transistor) Wide Range Voltage	L:<0.8VDC H:2 - 30VDC L:0 - 5VDC/AC H:20 - 250VDC/AC	Sink Current : 8μA Input Impedance : 300kΩ * 50/60 Hz Convertible
Reset Pulse Width	6ms MIN.		
Power Source	3.6V 1/2AA Lithium Battery (replaceable), 7 years min. with continuous input at 25°C *The battery life is not a guaranteed value.		
Compliance	CE, RoHS, UL		

DIMENSIONS : mm

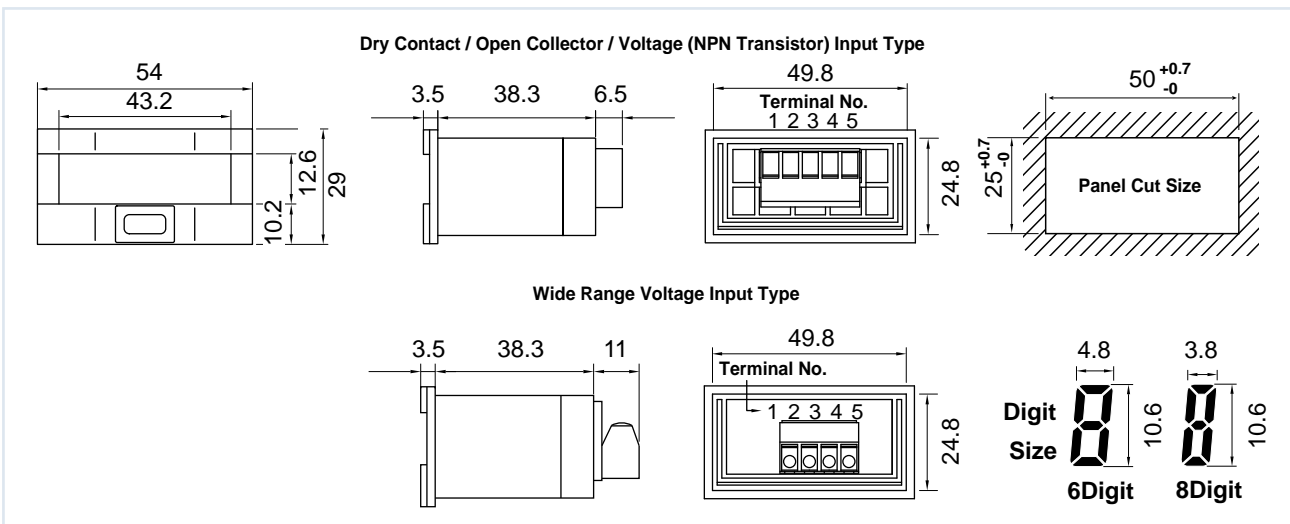

MODELS

E48 - □□□

Preset

- 1:1 Level Preset
- 2:2 Level Preset
- 3:1 Level Preset
- + Prewarn

Power

1:100 - 240VAC

Source 2:12 - 24VDC(E48-102 only)



SPECIFICATIONS

Model	E48-101	E48-102	E48-201	E48-301
Display	Blue STN LCD with white backlight ; Digit Size : 10 x 5mm			
No. of Digits	6			
No. of Digit Setting Keys	6			
Preset Level	1 Level	1 Level	2 Level	1 Level Preset + Prewarn
Setting Range	-99999 - 999999			
Prewarn Feature	-	-	-	0 - 999999
Input Mode	Contact / Open Collector / Voltage (Selectable)			
Input Signal	Open Collector (Sink Current Approx. 11mA) L : 0 - 4V / Voltage (Input Impedance 7K Ω) L : 0 - 4V H: 6 - 30V (Available to duplex wire DC sensor.)			
Count Speed	30Hz, 1kHz, 5kHz, 10kHz (Selectable)			
Count Mode	Add / Subtract (Add/Subtract individual input, 90° quadrature input)			
Count Range	-99999 - 999999			
Prescale	0.001 - 99.999 (0 setting is not available)			
Decimal Point Position	0.0, 0.00, 0.000, No Decimal Point			
Write	-99999 - 999999			
Reset	Front Panel Reset, Remote Reset, Auto-reset			
Remote Reset Time	2ms or 20ms (Selectable)			
Operation Mode	Modes A, B, C, D, E, F, G can be selected. Except for standard output, Mode A only is available for other output modes.			
Memory	E ² PROM (10 years, can be used 100,000 times)			
Output	Relay Output (Main: 1c, Sub: 1a) : load of 250VAC 5A / 30VDC 5A Maximum			
Output Delay	Relay Output /30Hz: 17ms MAX. ; 1kHz,5kHz,10kHz: 12ms MAX.			
Output Mode	1 Level Preset: Standard, Equal, Lower Limit, Upper Limit 2 Level Preset: Standard, Equal, Upper-Lower Limit, Upper-Upper Limit 1 Level Preset + Prewarn: Standard, Equal			
Output Time	Standard Output : One Shot (10 - 9990ms) or HOLD or HOLD 1 or HOLD 2 / Equal, Upper, Lower Output : Latched only when requirements are full			
Error Display	In 90° quadrature mode, error message will be displayed on the LCD if the count range is exceeded (overflow error : α - $\bar{E}r$ underflow error : \underline{u} - $\bar{E}r$)			
Power Supply	100 - 240VAC -15%, +10% 50/60 Hz Convertible	12 - 24VDC -15%, +10%	100 - 240VAC -15%, +10% 50/60 Hz Convertible	12VDC 100mA
Sensor Power Source	12VDC 100mA	-	12VDC 100mA	12VDC 100mA
Power Consumption	Approx. 7VA for 240VAC	Approx. 2.5W for 24VDC	Approx. 7VA for 240VAC	Approx. 7VA for 240VAC
Ambient Temp./Humidity:Operating	-10 - +50°C (Should not be frozen) 45 - 85%RH (Non-Condensing)			
Altitude	2,000m max.			
Installation Environment	Over-voltage Category II, Pollution Degree 2 (IEC61010-1)			
Front Panel	IP54 (Panel Surface)			
Compliance	CE, RoHS, UL in process			
Weight	Approx. 160g	Approx. 120g	Approx. 160g	Approx. 160g

DIMENSIONS : mm

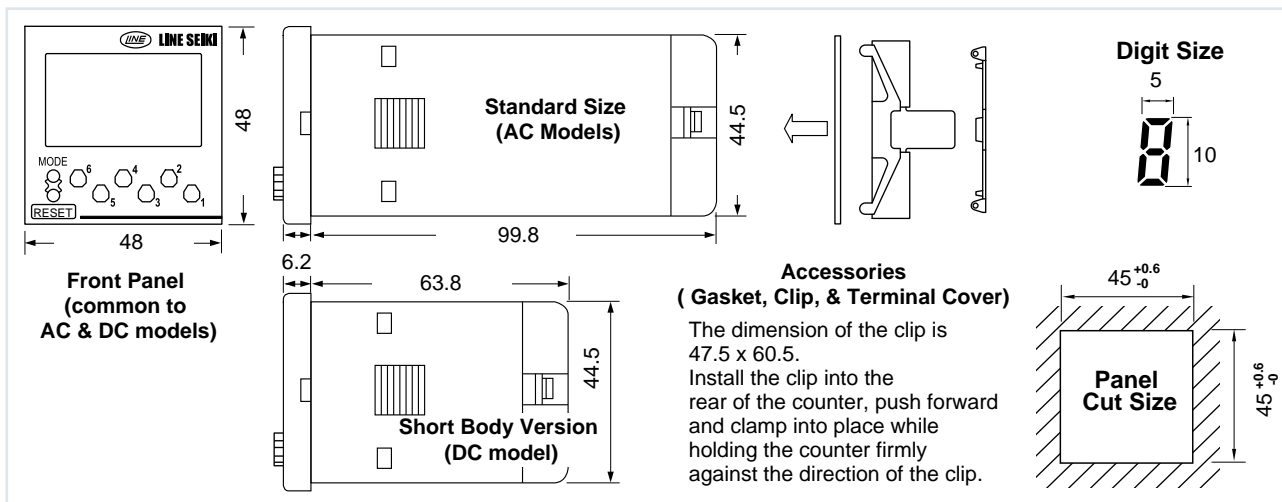

MODELS

G48 - 3□□

Preset

- 0:1 Level Preset
- 1:2 Level Preset
- 2:1 Level Preset
- + Prewarn

Power 5:100 - 240VAC

Source 6:12 - 24VDC(G48-306 only)



SPECIFICATIONS

Model	G48-305	G48-306	G48-315	G48-325
Display	LCD with backlight ; Digit Size : 10 x 5mm			
No. of Digits	6			
No. of Digit Setting Keys	6			
Preset Level	1 Level	1 Level	2 Level	1 Level Preset + Prewarn
Setting Range	-99999 - 999999			
Prewarn Feature	-	-	-	0 - 999999
Input Mode	Contact / Open Collector / Voltage (Selectable)			
Input Signal	Open Collector (Sink Current Approx. 10mA) L : 0 - 4V / Voltage (Input impedance 7KΩ) L : 0 - 4V H: 6 - 30V (Available to duplex wire DC sensor.)			
Count Speed	30Hz, 1kHz, 5kHz (Selectable)			
Count Mode	Add / Subtract (Add/Subtract individual input, 90° quadrature input)			
Count Range	-99999 - 999999			
Prescale	0.001 - 99.999 (0 setting is not available)			
Decimal Point Position	0.0, 0.00, 0.000, No Decimal Point			
Write	-99999 - 999999			
Reset	Front Panel Reset, Remote Reset, Auto-reset			
Remote Reset Time	2ms or 20ms (Selectable)			
Operation Mode	Modes A, B, C, D, E, F, G can be selected. Except for standard output, Mode A only is available for other output modes.			
Memory	E ² PROM (10 years, can be used 100,000 times)			
Output	Relay Output (1a) : load of 250VAC 5A / 30VDC 5A Maximum			
Output Delay	Relay Output /30Hz: 20ms MAX. ; 1kHz,5kHz: 7ms MAX.			
Output Mode	1 Level Preset: Standard, Equal, Lower Limit, Upper Limit 2 Level Preset: Standard, Equal, Upper-Lower Limit, Upper-Upper Limit 1 Level Preset + Prewarn: Standard, Equal			
Output Time	Standard Output : One Shot (10 ~ 9990ms) or HOLD or HOLD 1 or HOLD 2 / Equal, Upper, Lower Output : Latched only when requirements are full			
Error Display	In Add/subtract mode, error message will be displayed on the LCD if the count range is exceeded (overflow error : σ -Er underflow error : μ -Er)			
Key Lock	Key operation can be disabled at 4 protection levels (L1, L2, L3, L4) by selecting in Program Mode and shorting key lock terminals.			
Power Supply	100 - 240VAC -15%, +10% 50/60 Hz Convertible	12 - 24VDC -15%, +10%	100 - 240VAC -15%, +10%	100 - 240VAC -15%, +10% 50/60 Hz Convertible
Sensor Power Source	12VDC 100mA	-	-	12VDC 100mA
Power Consumption	Approx. 7VA for 240VAC	Approx. 1.2W for 24VDC	-	Approx. 7VA for 240VAC
Ambient Temp./Humidity:Operating	-10 ~ +50°C (Should not be frozen) 45 - 85%RH (Non-Condensing)			
Altitude	2,000m max.			
Installation Environment	Over-voltage Category II, Pollution Degree 2 (IEC61010-1)			
Front Panel	IP54 (Panel Surface)			
Compliance	CE, UL in process			
Weight	Approx. 170g	Approx. 110g	-	Approx. 170g

DIMENSIONS : mm

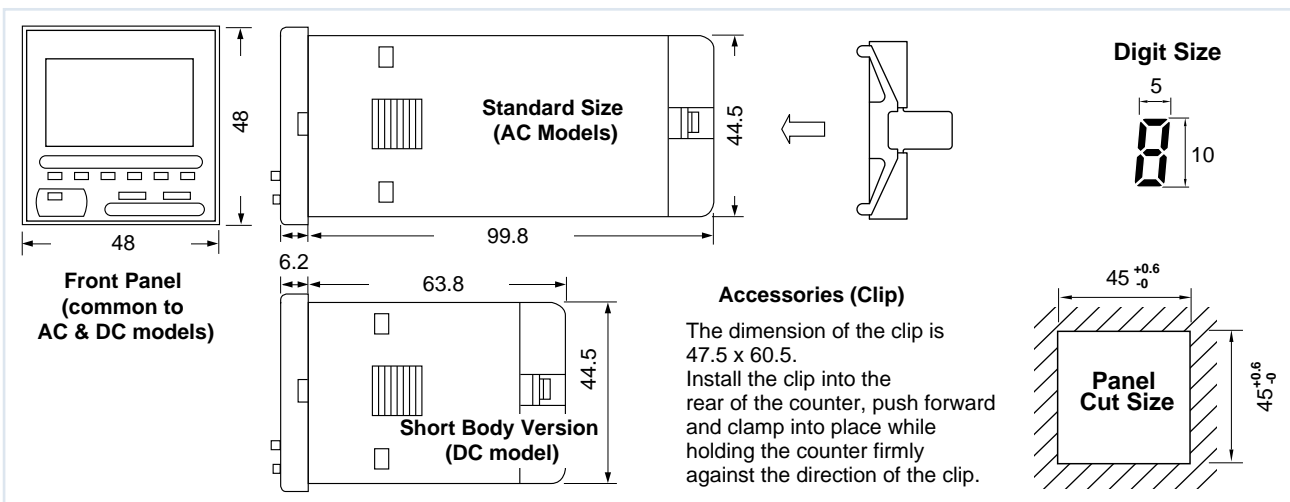

MODELS



Models	G20 Series	G21 Series	G62 Series	E60 Series	G10 Series
Type	Preset Counter				
Display	Red / Green LED		Red LED	LCD(Back Light)	Red / Green LED
No. of Digits	6		4	6	4 / 5 / 6
Digit Size (H)	14.22 / 10mm	10 / 8mm	10mm		10.16 / 14.22mm
Count Mode	Add / Subtract, 90°Quadrature				
Count Range	-99999 - +999999		0 - 9999	-99999 - +999999	0-9999/0-99999/0-999999
Count Speed	30 / 1K / 5K / 8KHz		25 / 10KHz	30 / 1K / 5K / 10KHz	20 / 10KHz
Preset Levels	1-4		1-2		
Preset Range	-99999 - +999999		0 - 9999	-99999 - +999999	0-9999/0-99999/0-999999
Reset	Front / Remote / Auto				Remote / Auto
Input	Contact Input Open Collector Input Votage Input				
Output	Relay(1c) / Open Collector		Relay(1a) / Open Collector	Relay (1c / 1a)	Relay (1c)
Memory	E ² PROM				
Power Source	100 - 240VAC				100 / 110 / 200 / 220VAC
Sensor Power Source	12VDC 100mA				12VDC 60mA
Power Consumption	7VA		5VA	7VA	4.3VA
Panel Cut Size	140 x 68mm	68 x 68mm	54 x 54mm	54 x 54mm	68 x 68mm
Size	144 x 72 x 66.1mm	72 x 72 x 77mm	60 x 60 106mm	60 x 60 106mm	72 x 72 x 125mm
Weight	Approx. 360g	Approx. 280g	Approx. 240g	Approx. 200g	Approx. 550g
Ambient Temp. : Operating	-10 - +50°C (Should not be frozen)				
Ambient Humidity : Operating	45 - 85%RH (Non-Condensing)				
Function	Free Right / Prescale / Key Protect / RS-485 Serial Communication		Key Protect / Input Inhibit	Free Wright / Prescale / Key Protect /	Select LED Color

Models	MD Series	MDR Series	G90 Series	G95 Series	F90 Series
Type	Totalizer / Preset Counter		Totalizer / Display	Totalizer / Display	Tachometer
Display	Red LED				Red / Green LED
No. of Digits	4	4 / 6	6		6
Digit Size (H)	14.22mm	14.22 / 10.16mm	56.8mm	101.6mm	14.22 / 10 / 8mm
Count Mode	Add	Add / Subtract, 90°Quadrature			-
Count Range	0 - 9999	0 - 9999 / 0 - 999999	0 - 9999 / 0 - 99999 / 0 - 999999		0.0001 - 999999
Count Speed	20 / 1KHz	20 / 5K Hz	20 / 1KHz		0.11Hz - 20KHz
Preset Levels	- / 1	- / 1 / 2	-		- / 2
Preset Range	0-9999	- / 0-9999 / 0-999999	-		0.0001 - 999999
Reset	Front / Remote / Auto			Remote	
Input	Contact Input Open Collector Input Votage Input				
Output	- / Relay(1c) / Open Collector		-		Relay(1c)
Memory	None or E ² PROM			E ² PROM	
Power Source	100 / 110 / 200 / 220VAC		100 - 240VAC		100-240VAC
Sensor Power Source	12VDC 30mA	12VDC 50mA	DC12V 100mA		12VDC 100mA / 50mA
Power Consumption	2.5 / 4VA	3.5 / 4.5 / 5.5VA	6VA		
Panel Cut Size	68 x 68mm	68(140) x 68mm	-		140 x 68mm
Size	72 x 72 x 125mm	72(144) x 72 x 125mm	626 x 195 x 47mm	401 x 149 x 47mm	96 x 48 x 106mm
Weight	Approx. 500 - 560g	Approx. 530 / 950 - 1050g	Approx. 3kg	Approx. 1.5kg	Approx. 280g
Ambient Temp. : Operating	0 - 40°C / -5 - +40°C *		-10 - +50°C *		-5 - +50°C *
Ambient Humidity : Operating	45 - 85%RH *				
Function	Optional : BCD Output / Dust Proof Cover		Decimal Point Position Setting / Bracket Set Switching function of the display and counter		Rate Indicators/Controllers Magnetic sensor input L:-0.6 - 17V H:0.6 - 17V

* Should not be frozen, Non-Condensing

MODELS

MZ - □□□ - □

Digit

6:6 digits
7:7 digits

Voltage

12VDC
24VDC

Mounting & Connection

- 00:Rear / Leadwire
- 20:Base (Horizontal) / Leadwire
- 30:Behind Panel (Screw) / Leadwire
- 40:Base (Vertical) / Leadwire
- 70:Panel (Snap-in) / Leadwire
- 02:Rear (Mounting Pitch : 15mm) / Terminal Pins (Pitch =12.7mm)
- 12:Rear (Mounting Pitch : 20mm) / Terminal Pins (Pitch =10mm)

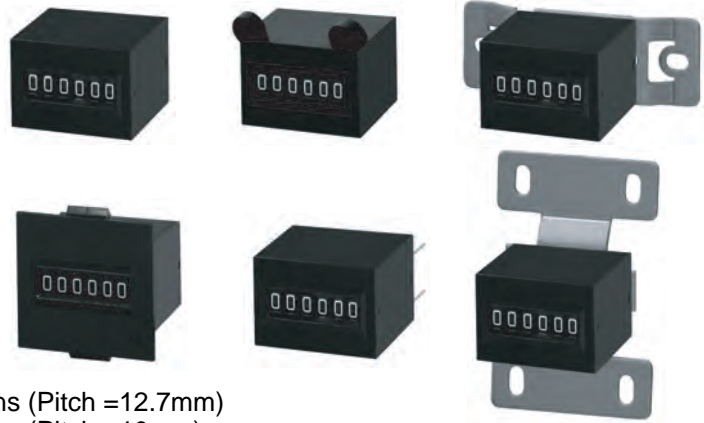

SPECIFICATIONS

Display	6digits : 3.0 x 2.0mm / 7digits : 3.0 x 1.6mm (white on black background)
Power Source	12VDC, 24VDC
Voltage Fluctuation	-15% - +10%
Power Consumption	1.2W
Continuous Energizing	Permissible
Counting Method	One Pulse - One Count (Energizing - 1/2 count, Unenergized - 1/2 count)
Counting Speed	10Hz, 20Hz (Maximum)
Pulse Width	50ms (Minimum)
Make (Duty)	1 : 1
Count Life	6digits : 3,000,000 Counts Minimum / 7digits : 10,000,000 Counts Minimum
Reset	None
Connection	Lead Wire 250mm / PCB Type : Pin
Ambient Temp. : Operating	-5 - +40°C (Should not be frozen)
Ambient Humidity : Operating	85%RH Maximum (Non-Condensing)
Test Voltage	1,500VAC for 1 Minute
Insulation Resistance	50MΩ Minimum (500VDC Megger)
Vibration	Destraction : 16.7 Hz : Double Amplitude 4mm Malfunction : 10 - 55 Hz : Double Amplitude 0.5mm
Shock	Destraction : 30G Malfunction : 5G
Construction	Cover : Plastic (Noryl UL94V-1,Black) / Base: Steel
Weight	Approx.30g
Compliance	CE, RoHS, UL

DIMENSIONS : mm

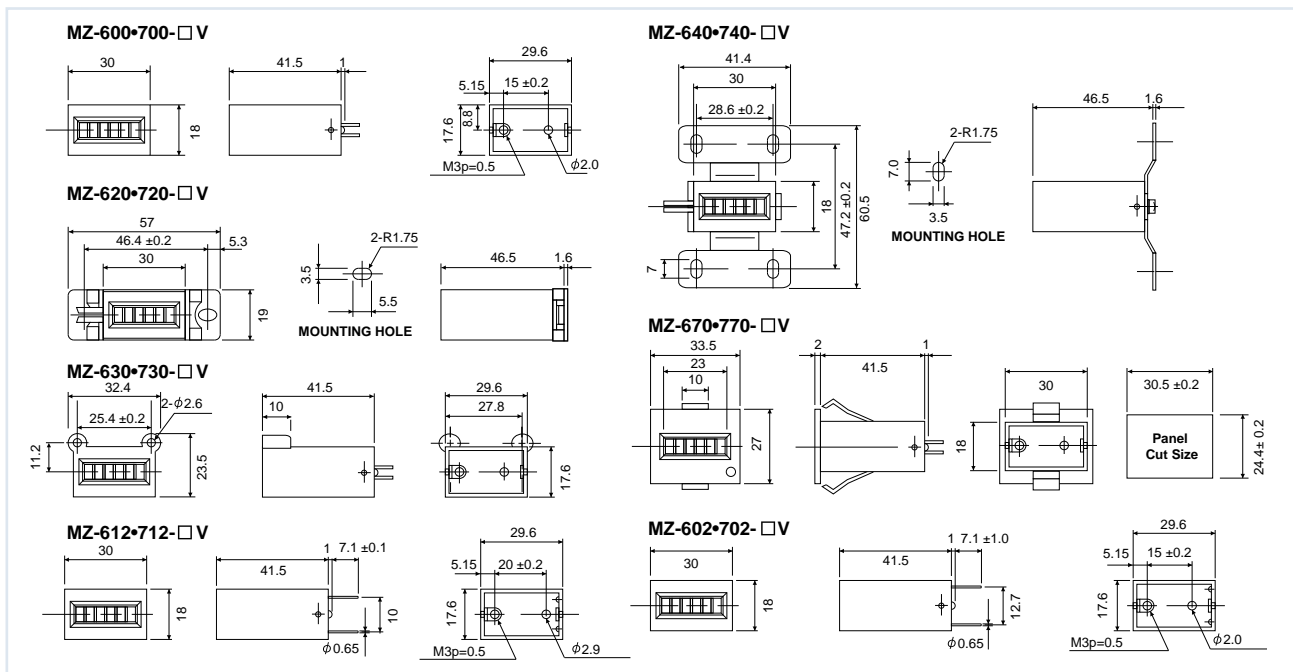

MODELS

ME - □□□□ - □

Digit

6:6 digits
7:7 digits

Voltage

100VAC
200VAC
220VAC
12VDC
24VDC

Mounting

0:Rear
2:Base (Horizontal)
3:Behind Panel (Screw)
4:Base (Vertical)
7:Panel (Snap-in)

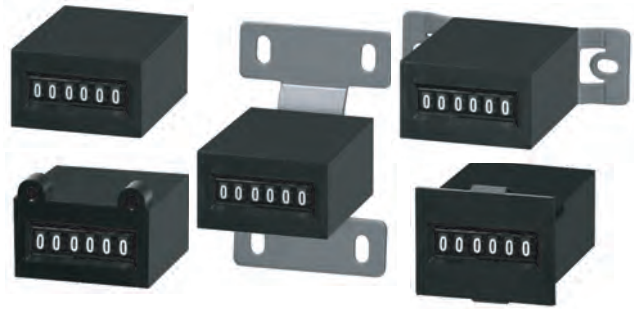

SPECIFICATIONS

Display	6digits : 3.5 x 1.8mm / 7digits : 33.5 x 1.4mm (white on black background)
Power Source	100 / 200 / 220 VAC 50/60 Hz Convertible 12 / 24VDC
Voltage Fluctuation	-15% - +10%
Power Consumption	AC : 1.1 - 2.1VA / DC : 1.2W
Continuous Energizing	Permissible
Counting Method	One Pulse - One Count (Energizing - ½ count, Unenergized - ½ count)
Counting Speed	10Hz (Maximum)
Pulse Width	50ms (Minimum)
Make (Duty)	1 : 1
Count Life	3,000,000 Counts Minimum
Reset	None
Connection	Lead Wire 250mm
Ambient Temp. : Operating	-5 - +40°C (Should not be frozen)
Ambient Humidity : Operating	85%RH Maximum (Non-Condensing)
Test Voltage	1,500VAC for 1 Minute
Insulation Resistance	50MΩ Minimum (500VDC Megger)
Vibration	Destruction : 16.7 Hz : Double Amplitude 4mm Malfunction : 10 - 55 Hz : Double Amplitude 0.5mm
Shock	Destruction : 30G / Malfunction : 5G
Construction	Cover : Plastic (Noryl UL94V-1,Black) / Base: Steel
Weight	ME-□□00-□V : Approx. 50g, ME-□□20-□V : Approx. 60g, ME-□□30-□V : Approx. 52g, ME-□□40-□V : Approx. 60g, ME-□□70-□V : Approx. 55g,
Compliance	CE, RoHS, UL

DIMENSIONS : mm

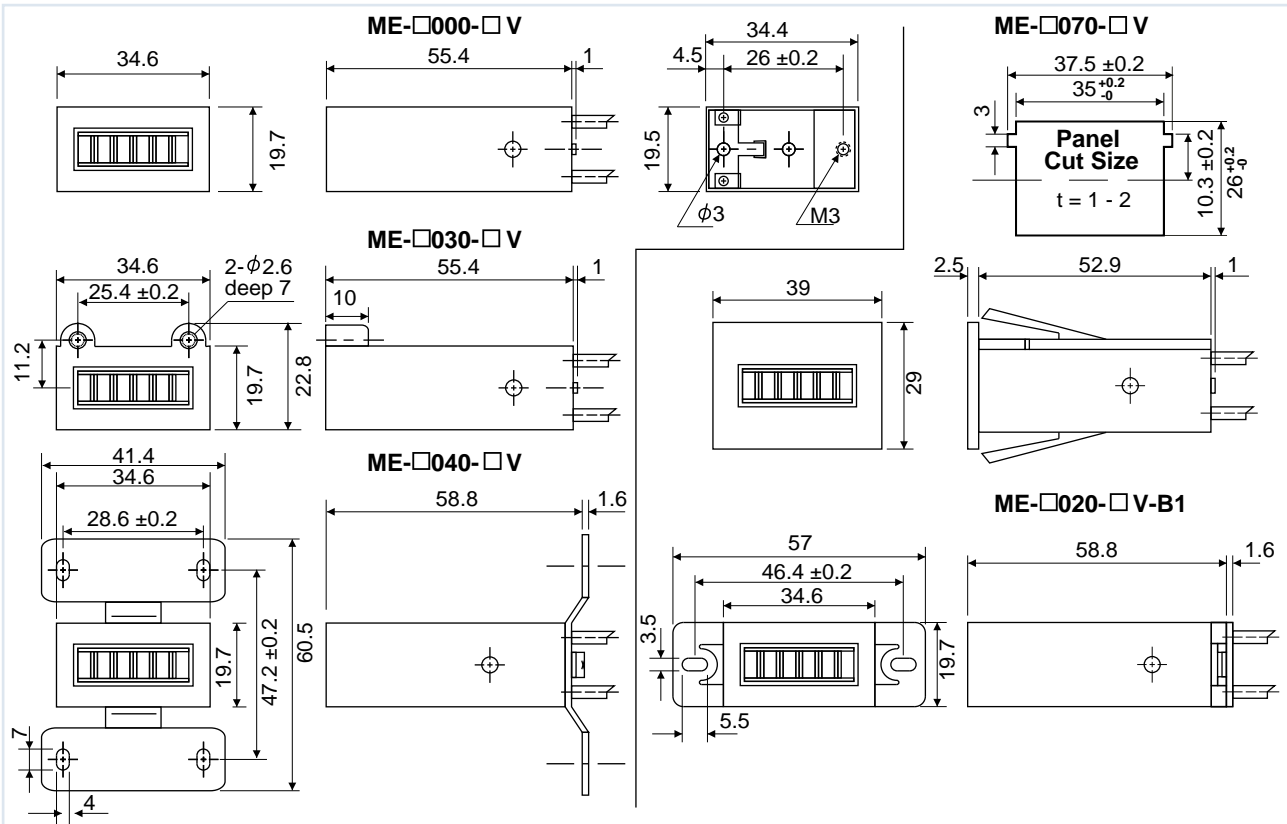

MODELS

MCU - □□ - □

Digit	Mounting	Voltage
6:6 digits	S:Rear	100VAC
7:7 digits	P:Panel (Screw)	200VAC
	C:Base (Horizontal)	220VAC
	CY:Base (Vertical)	24VDC

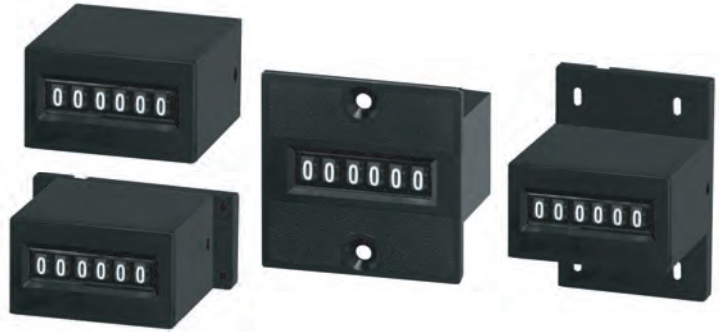

SPECIFICATIONS

Display	6digits : 4.3 x 2.6mm / 7digits : 4.3 x 2.0mm (white on black background)
Power Source	100 / 200 / 220VAC 50/60 Hz Convertible 24VDC
Voltage Fluctuation	±10%
Power Consumption	AC : 3.4 - 4.3VA / DC : 1.7W
Continuous Energizing	AC : less than 5 minutes / DC : Permissible
Counting Method	One Pulse - One Count (Energizing - ½ count, Unenergized - ½ count)
Counting Speed	10Hz (Maximum)
Pulse Width	50ms (Minimum)
Make (Duty)	1 : 1
Count Life	10,000,000 Counts Minimum
Reset	None
Connection	Lead Wire 250mm
Ambient Temp. : Operating	-5 - +40°C (Should not be frozen)
Ambient Humidity : Operating	85%RH Maximum (Non-Condensing)
Test Voltage	1,500VAC for 1 Minute
Insulation Resistance	50MΩ Minimum (500VDC Megger)
Vibration	Destraction : 16.7 Hz : Double Amplitude 4mm Malfunction : 10 - 55 Hz : Double Amplitude 0.5mm
Shock	Destraction : 30G / Malfunction : 5G
Construction	Cover : Plastic (Noryl UL94V-1,Black) / Base: Plastic
Weight	MCU-□S-□V : Approx. 85g, MCU-□P-□V : Approx. 100g, MCU-□C-□V : Approx. 100g, MCU-□CY-□V : Approx. 105g
Compliance	CE, RoHS, UL

DIMENSIONS : mm

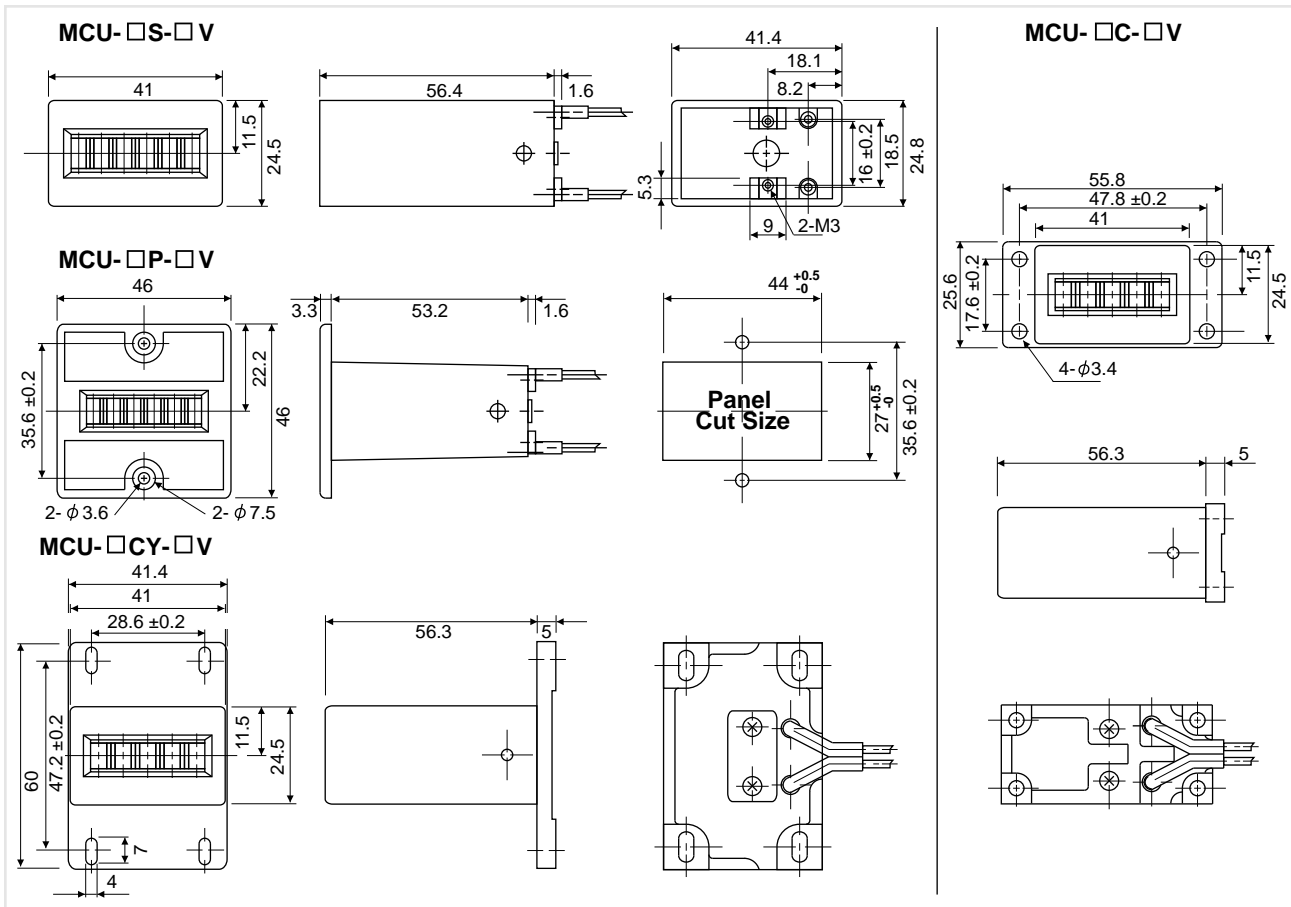

MODELS

MCF - □□ - □ **Voltage**
Digit **Mounting**
 4:4 digits X:Panel (Clip)
 6:6 digits P:Panel (Screw)
 100VAC
 110VAC
 200VAC
 220VAC
 12VDC
 24VDC



SPECIFICATIONS

Display	4.0 x 2.4mm (white on black background)
Power Source	100 / 110 / 200 / 220VAC 50/60 Hz Convertible 12 / 24VDC
Voltage Fluctuation	-15% - +10%
Power Consumption	AC : 2.8 - 3.1VA / DC : 2.0 - 2.1W
Continuous Energizing	Permissible
Counting Method	One Pulse - One Count (Energizing - ½ count, Unenergized - ½ count)
Counting Speed	10Hz (Maximum)
Pulse Width	50ms (Minimum)
Make (Duty)	1 : 1
Count Life	10,000,000 Counts Minimum
Reset	Manual Reset (Push Button)
Connection	Lead Wire 250mm
Ambient Temp. : Operating	-5 - +40°C (Should not be frozen)
Ambient Humidity : Operating	85%RH Maximum (Non-Condensing)
Test Voltage	1,500VAC for 1 Minute
Insulation Resistance	50MΩ Minimum (500VDC Megger)
Vibration	Destraction : 16.7 Hz : Double Amplitude 4mm Malfunction : 10 - 55 Hz : Double Amplitude 0.5mm
Shock	Destraction : 30G / Malfunction : 5G
Construction	Cover : Plastic (Noryl UL94V-1,Gray)
Weight	MCF-4X / P - □V: Approx. 100g, MCF-6X / P - □V : Approx. 120g
Compliance	CE, RoHS, UL

DIMENSIONS : mm

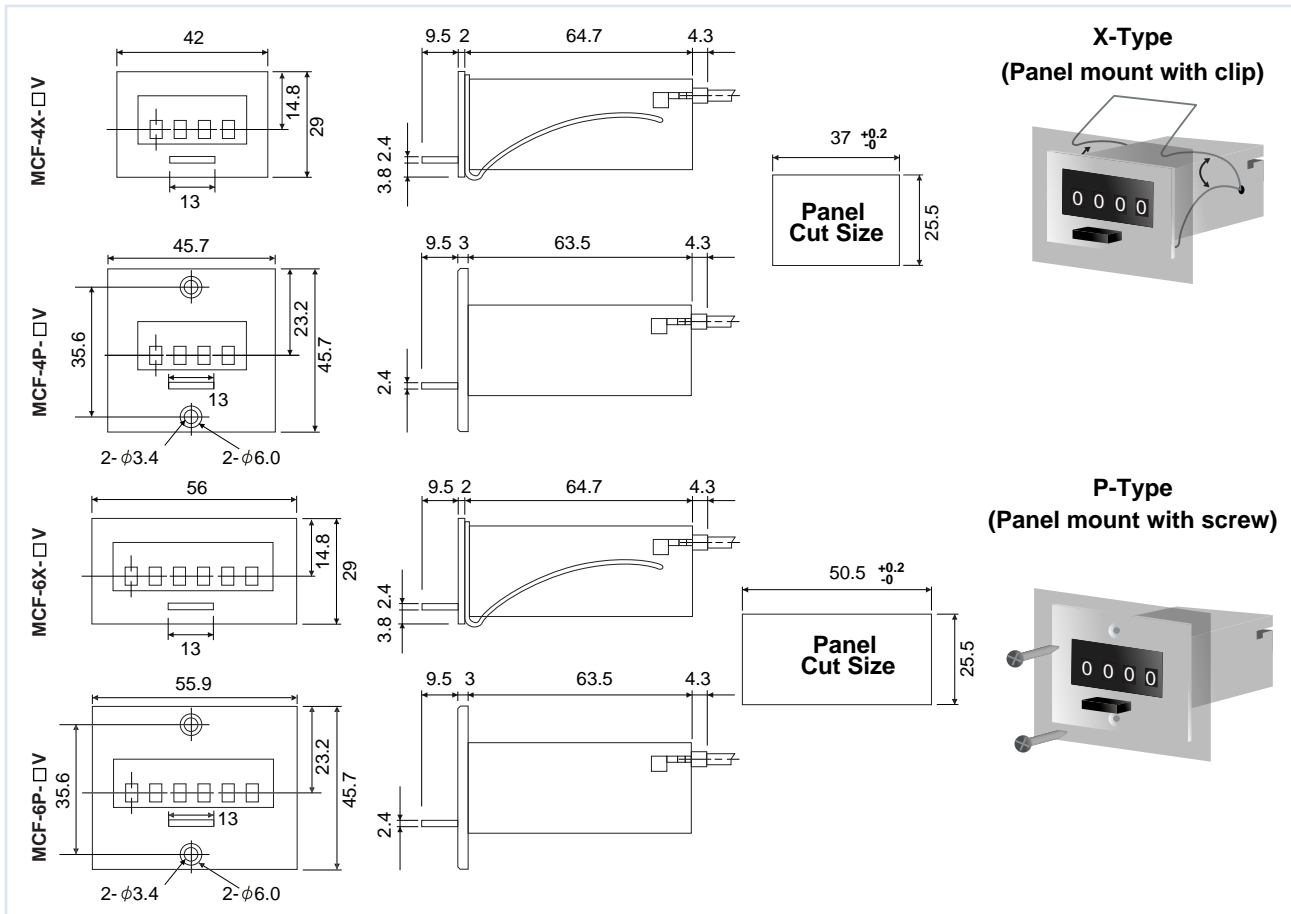

MODELS

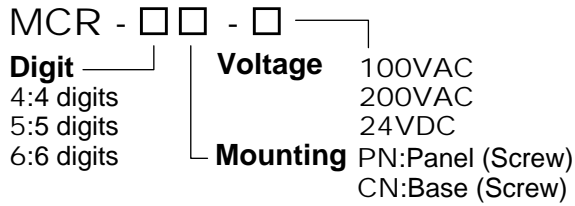

SPECIFICATIONS

Display	4 or 5 digits : 5.4 x 3.8mm / 6 digits : 5.4 x 2.8mm (white on black background)
Power Source	100 / 200VAC 50/60 Hz Convertible 24VDC
Voltage Fluctuation	-10% - +10%
Power Consumption	AC : 3.7 - 4.2VA DC : 3.3W
Continuous Energizing	Permissible
Counting Method	One Pulse - One Count (Energizing - ½ count, Unenergized - ½ count)
Counting Speed	15Hz (Maximum)
Pulse Width	33ms (Minimum)
Make (Duty)	1 : 1
Count Life	10,000,000 Counts Minimum
Reset	Manual Reset (Push Button)
Connection	Soldering Terminal, Lead Wire 250mm (CN type: lead wire only)
Ambient Temp. : Operating	-5 - +40°C (Should not be frozen)
Ambient Humidity : Operating	85%RH Maximum (Non-Condensing)
Test Voltage	1,500VAC for 1 Minute
Insulation Resistance	20MΩ Minimum (500VDC Megger)
Vibration	Destruction : 16.7 Hz : Double Amplitude 4mm Malfunction : 10 - 55 Hz : Double Amplitude 0.5mm
Shock	Destruction : 30G / Malfunction : 5G
Construction	Cover : Plastic (Noryl UL94V-1,Black)
Weight	MCR- □PN- □V : Approx. 260-265g, MCR- □CN- □V : Approx. 275-280g
Compliance	CE, RoHS, UL

DIMENSIONS : mm

MCR- □PN- □V

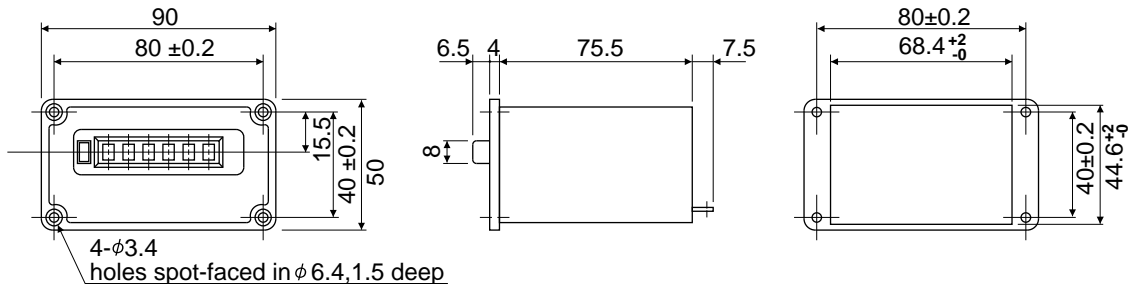

MCR- □CN- □V

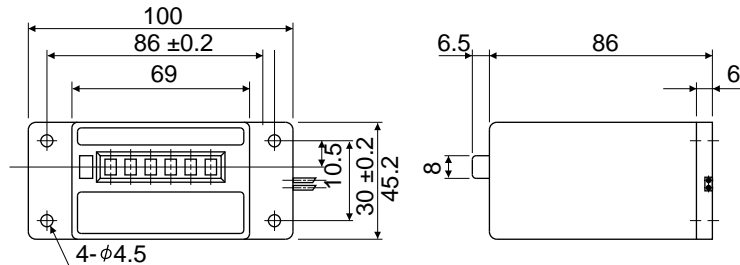

MODELS (Counter)

Models	MA Series	MB Series	MCP-35 Series
Type	Preset Counter		
No. of Digits	4 / 6	5 / 6	5
Digit Size	3.8 x 2.6 / 3.6 x 2.4mm	3.8 x 2.6mm	4.3 x 2.5mm
Count Mode	Add		
Count Range	0 - 9999 / 0 - 99999	0 - 9999 / 0 - 99999	0 - 99999
Count Speed	10KHz		15KHz
Preset Levels	1		
Preset Range	0 - 9999 / 0 - 99999	0 - 9999 / 0 - 99999	0 - 99999
Reset	Front / Remote		Front / Auto
Output	Relay(1c)		
Power Source	100V/110V/200V/220ACV 50/60Hz Convertible 24VDC	100V / 200VAC 50/60Hz Convertible 24VDC	100V/110V/200V/220ACV 50/60Hz Convertible
Power Consumption	Count:AC4.7-5.0VA/DC3.6W Reset:AC20.6-20.7VA/DC15.7W	Count:AC5.0VA/DC3.6W Reset:AC25VA/DC16W	AC8.9 - 10.5VA
Panel Cut Size	54 x 54mm		92 x 69mm
Weight	Approx. 260 - 290g		Approx. 880g
Ambient Temp. : Operating	-5 - +40°C		
Ambient Humidity : Operating	85%RH		
Function	Dust Proof		Metal frame/Preset Bottom
Mounting	Panel mount with clip		Panel mount with Screw





MODELS (Hour Meter)

Model No.	Supply Voltage	Frequency
HK-3001	AC	110 - 120V
HK-3011		110 - 120V
HK-3021		220 - 240V
HK-3031		220 - 240V
HK-3041	DC	6 - 12V
HK-3051		12 - 36V
HK-4601	AC	110 - 120V
HK-4611		110 - 120V
HK-4621		220 - 240V
HK-4631		220 - 240V
HK-4661	DC	6 - 30V

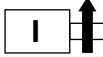
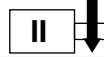
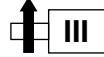

Models	HK-30 Series (AC ver.)	HK-46 Series (AC ver.)	HK-30 Series (DC ver.)	HK-46 Series (DC ver.)
Type	Hour Meter			
No. of Digits	5 integers 2 decimals		6 integers 1 decimals	
Digit Size	4mm			
Count Mode	Add			
Count Range	0.00-99999.99 hours		0.0-999999.9 hours	
Reading accuracy	1 /100 hour (36 sec.)		1 /10 hour (6 min.)	
Color of digit	integers: white on black / decimals : red on black			
Motor	Synchronous motor		Step motor	
Protection class	IP65 front side			
Mounting	Fork clamp			
Connection	Flat pins (6.3 x 0.8mm) with screw terminals			
Ambient Temp. : Operating	-25 - +70°C	-25 - +80°C	-10 - +55°C	-20 - +70°C
Power Source	-10% / +10%			
Panel Cut Size	33 x 22mm	46 x 46mm	33 x 22mm	46 x 46mm
Weight	Approx. 40g	Approx. 50g	Approx. 40g	Approx. 50g
Option	HK-30P : DIN 48 x 24mm panel	HK-46A : DIN rail adapter	HK-30P : DIN 48 x 24mm panel	HK-46A : DIN rail adapter

MODELS

	Type (I)	Type (II)	Type (III)	Type (IV)
Models	RS-204-5(I) RS-4(I) RS-5(I)	RS-204-5(II)	RSL-204-5(III)	RSL-204-5(IV)
Rotation	 Right Shaft Top-going	 Right Shaft Top-coming	 Left Shaft Top-going	 Left Shaft Top-coming



SPECIFICATIONS

Type	Ratchet : Adds 1 count for each 40° - 45° actuation of lever.
Digits	5 digits / RS-4 : 4 digits
Figures	RS-204 : 4.8 x 2.4mm / RS-4,RS-5 : 4.4 x 2.8mm
Count Speed	200 - 500 Counts / Minute
Measuring Range	0 - 99999 / RS-4 : 0 - 9999
Reset	Rotary Knob
Weight	Approx. 50 - 60g
Ambient Temp. : Operating	-5 - +40°C (Should not be frozen)
Ambient Humidity : Operating	85%RH Maximum (Non-condensing)
Compliance	RoHS

DIMENSIONS : mm

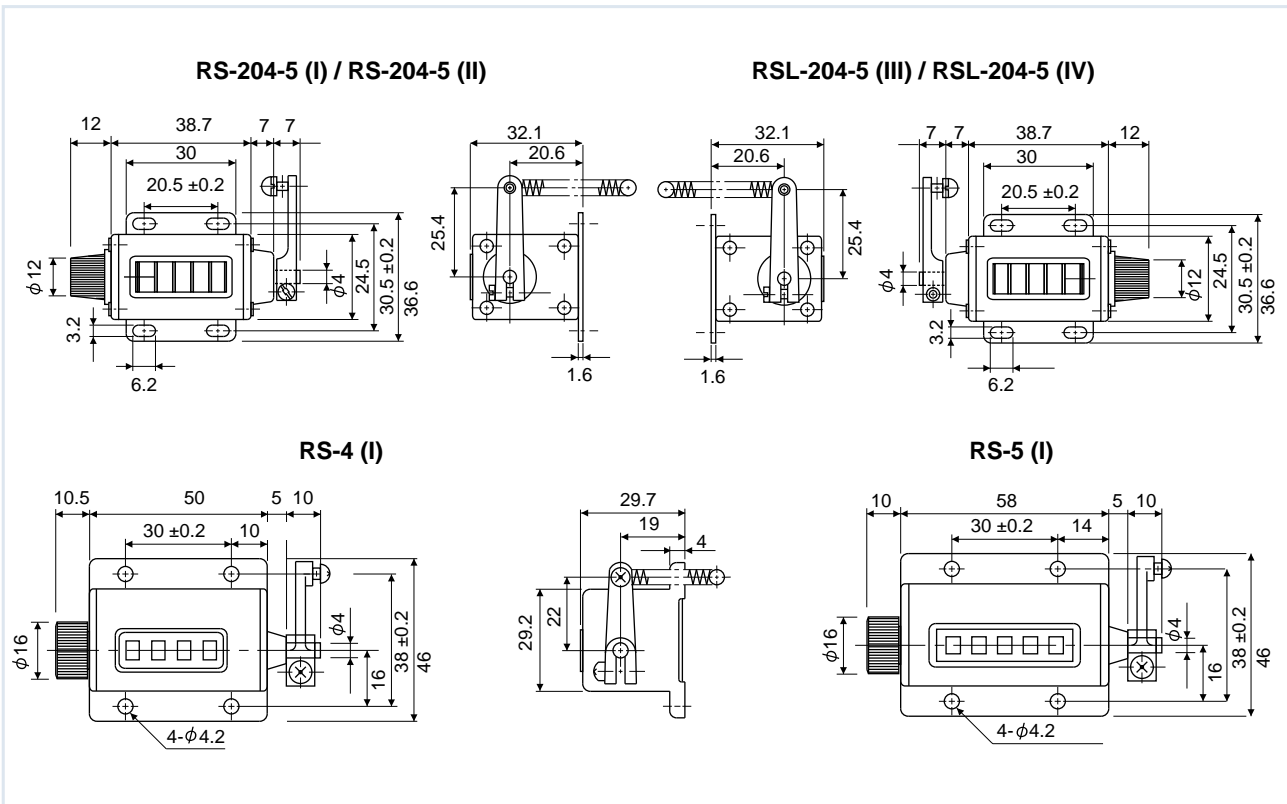

MECHANICAL COUNTER OPERATION

Adds 1 count for each 40° - 45° actuation of lever

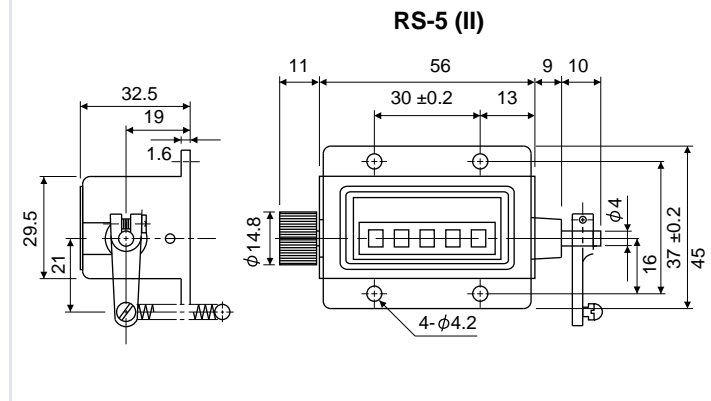
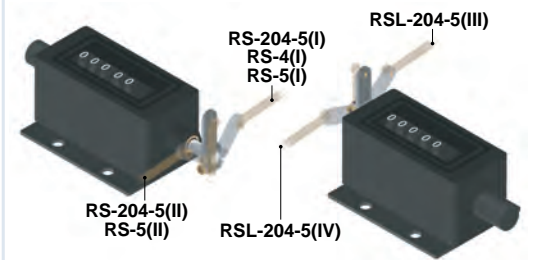

MODELS (RS / LB / SP-10 / RL / SR Series)

Count Type	Type (I)	Type (II)	Digits	Figures	Weight (Approx.)
Ratchet	RS-6 (I)		6	4.4 x 2.8mm	120g
	RS-303-5 (I)		5	6.0 x 4.5mm	120g
Revolution	LB-4 (I)		4	4.4 x 2.8mm	90g
	LB-5 (I)		5	4.4 x 2.8mm	100g
	SP-101-4(I)	SP-101-4(II)	4	6.0 x 4.0mm	210g
	SP-101-5(I)	SP-101-5 (II)	5	6.0 x 4.0mm	210g
Direct Drive	RL-4(I)		4	4.4 x 2.8mm	90g
	RL-5(I)		5	4.4 x 2.8mm	100g
	RL-219-5(I)		5	6.0 x 4.5mm	110g
	SR-4(I)		4	4.3 x 2.8mm	60g
	SP-102-4(I)	SP-102-4 (II)	4	6.0 x 4.0mm	210g
	SP-102-5(I)	SP-102-5 (II)	5	6.0 x 4.0mm	210g



RS-303-5(I)



LB-4(I)



SP-101-4(I)

Models	Type (I)	Type (II)
Rotation		
	Shaft on right Top-going	Shaft on right Top-coming

* SP-101 / SP-102 is Double Shaft.

- **Ratchet**
Adds 1 count for each 40° - 45° actuation of lever.
- **Revolution**
Adds 1 count for every complete revolution of the shaft.
- **Direct Drive**
Adds 10 counts for every complete revolution (1 count / 1/10 shaft revolution) of the shaft.

MODELS (Preset Mechanical Counter SP Series)



SP-14(I)

Count Type	Type (I)	Type (II)	Type (III)	Type (IV)	Type A	Digits	Figures	Weight (Approx.)
Revolution	SP-14(I)	SP-14(II)	SPL-14(III)	SPL-14 (IV)	SP-14A	4	6.0 x 3.5mm	600g
	SP-15(I)	SP-15(II)	SPL-15(III)	SPL-15 (IV)	SP-15A	5	5.5 x 2.6mm	600g
Direct Drive	SP-24(I)	SP-24(II)	SPL-24(III)	SPL-24 (IV)		4	6.0 x 3.5mm	610g
	SP-25(I)	SP-25(II)	SPL-25(III)	SPL-25 (IV)		5	5.5 x 2.6mm	610g

Models	Type (I)	Type (II)	Type (III)	Type (IV)	Type A
Rotation					
	Shaft on right Top-going	Shaft on right Top-coming	Shaft on left Top Going	Shaft on left Top Coming	Shaft at base Anti-clockwise

- **Revolution**
Adds 1 count for every complete revolution of the shaft.
- **Direct Drive**
Adds 10 counts for every complete revolution (1 count / 1/10 shaft revolution) of the shaft.
- **Preset**
1 Preset Level. **Output** Microswitch - Type 1C (250VAC, 10A max.) x 2 units

SPECIFICATIONS

Ambient Temp. : Operating	-5 - +40°C (Should not be frozen)
Ambient Humidity : Operating	85%RH Maximum (Non-Condensing)

MODELS

RY Series

RY-3:10-5 (I)
RY-3:100-5 (I)

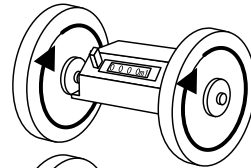
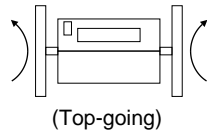

RY-3:10-5 (II)
RY-3:100-5 (II)

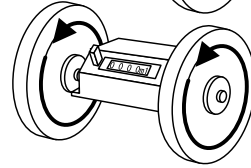
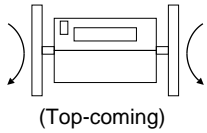

MWC Series

MWC-3:1-5 (I)
MWC-3:10-5 (I)

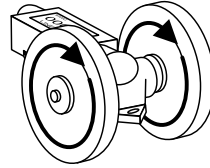
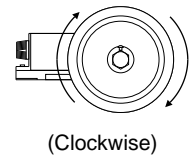

MWC-3:1-5 (II)
MWC-3:10-5 (II)

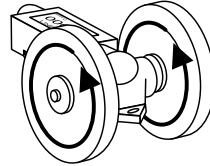
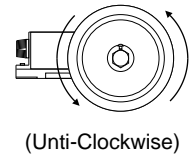

SPECIFICATIONS

Models	Figures	Rotations for Additive	Unit of Measurements	Maximum Count Speed	Torque	Weight (Approx.)
RY-3:10-5 (I)	5	Top-going	0.1 m	300 m/min	150gcm	730g
RY-3:10-5 (II)	5	Top-coming	0.1 m	300 m/min	150gcm	730g
RY-3:100-5 (I)	5	Top-going	0.01 m	30 m/min	250gcm	730g
RY-3:100-5 (II)	5	Top-coming	0.01 m	30 m/min	250gcm	730g
MWC-3:1-5 (I)	5	Clockwise	1 m	300 m/min	150gcm	545g
MWC-3:1-5 (II)	5	Anti-Clockwise	1 m	300 m/min	150gcm	545g
MWC-3:10-5 (I)	5	Clockwise	0.1 m	30 m/min	150gcm	545g
MWC-3:10-5 (II)	5	Anti-Clockwise	0.1 m	30 m/min	150gcm	545g

2 pieces of wheels are furnished as standard accessories. Please pay attention to the copy products in the market.

Color of Figure

RY-3:10-5 (I)



RY-3:100-5 (I)

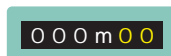

MWC-3:1-5 (I)



RY-3:10-5 (II)

First figure is Yellow on Black background. Others are White on Black background.

RY-3:100-5 (II)

First and second figure are Yellow on Black background. Others are White on Black background.

MWC-3:10-5 (I)



All figures are White on Black background.

Ambient Temp. : Operating -5 - +40°C Ambient Humidity: Operating 85%RH Maximum Remarks Should not be frozen, Non-Condensing

DIMENSIONS : mm

RY-3 : 10-5 / RY-3 : 100-5

157, 81, 48, 4, 6, 53, 49.5, 2, 16, 17, 61 ±0.2, 71, 52 ±0.2, 4-φ4.3, φ7.5

MWC-3 : 1-5 / MWC-3 : 10-5

59, 25, 47, 38, 48, 32, 68, 39, 8, 20, 134, 3-φ5.5, φ7.5

WHEEL

Unit of Measure	Meter	Yard	Meter Wheel	Yard Wheel
Models	MRM096	MRM097	26	26
Type of Surface	Plain		18	18
Material of Surface	Elastomer		φ106.1 ^{+0.3} ₋₀	φ97 ^{+0.3} ₋₀

ATTENTION !!!

Rubber pulleys are subject to slip for wear in the long usage. It will cause measuring discrepancies. Please check the pulleys sometimes and exchange to new ones.

2nd-5th wheel

1st wheel for MWC-3:10-5

1st wheel for MWC-3:1-5

MODELS

Models	Sensor	Unit of Measurements	Maximum Count Speed	Weight (Approx.)	Torque	Proper Counter
CT1-3:1	Microswitch	1 m	240 m/min	700g	153gcm	Electronic Counter
CT1-3:10		0.1 m	24 m/min	710g		Electromagnetic Counter
CT1-3:1A	Photoelectronic Sensor, 1 Non-contact Output	1 m	700 m/min	730g		Electronic Counter
CT1-3:10A		0.1 m	500 m/min	730g		
CT1-3:100A		0.01 m	250 m/min	740g		
CT1-3:1000A		0.001 m	100 m/min	790g		
CT1-3:1R	Photoelectronic Sensor, 2 Non-contact Outputs (90° Quadrature Output)	1 m	700 m/min	740g		Bidirectional Electronic Counter
CT1-3:10R		0.1 m	500 m/min	740g		
CT1-3:100R		0.01 m	250 m/min	750g		
CT1-3:1000R		0.001 m	100 m/min	780g		

* Factory-installed Option : Open collector output is available in 1 and 2 non-contact outputs models.
"C" should be added to the model number. (Ex.) CT1-3:10AC-YP

SPECIFICATIONS

Models	Output	Power Source	Current Consumption	Output Impedance	Maximum Load Current
CT1-3:1/10	1 Output	Microswitch Contact output, Capacity : 250VAC 10A , 125VDC 0.5A (Load)			
CT1-3:1/10/100A	1 Output	5 - 24VDC ±10%	35mA	3.9KΩ	100mA
CT1-3:1000A	1 Output	5 - 12VDC ±10%	20mA	2KΩ	20mA
CT1-3:1/10/100R	2 Outputs(90°Quadrature)	5 - 24VDC ±10%	70mA	3.9KΩ	100mA
CT1-3:1000R	2 Outputs(90°Quadrature)	5 - 12VDC ±10%	40mA	2KΩ	20mA

* 2 pieces of wheels are furnished as standard accessories. When you order, please specify type of wheels (meter or yard).
Please pay attention to the copy products in the market.

Ambient Temp. : Operating	-10 - +50°C
Ambient Humidity : Operating	35 - 85%RH Maximum
Remarks	Should not be frozen, Non-Condensing
Compliance	CE, RoHS

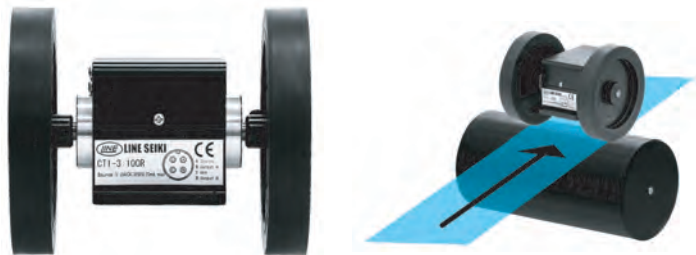

DIMENSIONS : mm

CT1-3:1/10

CT1-3:1/10/100/1000A(C) CT1-3:1/10/100/1000R(C)

WHEEL

Unit of Measure	Meter	Yard
Models	MRM096	MRM097
Type of Surface	Plain	
Material of Surface	Elastomer	

ATTENTION !!!

Rubber pulleys are subject to slip for wear in the long usage. It will cause measuring discrepancies. Please check the pulleys sometimes and exchange to new ones.

Meter Wheel Yard Wheel

MODELS (Pulse Generator)

Models	Sensor	Unit of Measurements	Maximum Count Speed	Torque	Weight (Approx.)	Proper Counter
CS-3:1	Reed switch	1 m	500 m/min	153gcm	740g	Electronic Counter Electromagnetic Counter



MODELS (Length Measuring Counter)

Models	Figures	Rotations for Additive	Unit of Measurements	Maximum Count Speed	Torque	Weight (Approx.)
SP-3:1-4 (I)	4	Clockwise	1 m	500 m/min	204gcm	1400g
SP-3:1-4 (II)	4	Anti-Clockwise	1 m	500 m/min	204gcm	1400g
SP-3:10-4 (I)	4	Clockwise	0.1 m	50 m/min	204gcm	1400g
SP-3:10-4 (II)	4	Anti-Clockwise	0.1 m	50 m/min	204gcm	1400g
SP-3:1-5 (I)	5	Clockwise	1 m	500 m/min	255gcm	1400g
SP-3:1-5 (II)	5	Anti-Clockwise	1 m	500 m/min	255gcm	1400g
SP-3:10-5 (I)	5	Clockwise	0.1 m	50 m/min	255gcm	1400g
SP-3:10-5 (II)	5	Anti-Clockwise	0.1 m	50 m/min	255gcm	1400g

2 pieces of wheels are furnished as standard accessories. Please pay attention to the copy products in the market.

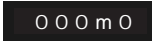
Color of Figure

SP-3:1-4 (I) **SP-3:10-4 (I)** 
SP-3:1-4 (II) **SP-3:10-4 (II)** 
 White on Black background.

SP-3:1-5 (I) **SP-3:10-5 (I)** 
SP-3:1-5 (II) **SP-3:10-5 (II)** 
 White on Black background.

Ambient Temp. : Operating -5 - +40°C **Ambient Humidity:Operating** 85%RH Maximum **Remarks** Should not be frozen, Non-Condensing

MODELS (Encoder)

CB -

Output

- C: Open Collector Output
- V: Voltage Output
- D: Line Driver Output (5VDC only)

Supply Voltage

- H: 12-24VDC (Open Collector Output only)
- L: 5-12VDC

Resolution

100:100PPR	500:500PPR	1500:1500PPR
200:200PPR	600:600PPR	1800:1800PPR
250:250PPR	800:800PPR	2000:2000PPR
300:300PPR	1000:1000PPR	2048:2048PPR
360:360PPR	1024:1024PPR	2500:2500PPR
400:400PPR	1200:1200PPR	

CE -

Resolution

- 60:60PPR
- 100:100PPR
- 200:200PPR
- 250:250PPR
- 300:300PPR
- 360:360PPR
- 400:400PPR
- 500:500PPR



SPECIFICATIONS (Encoder)

Models	CB- <input type="checkbox"/> HC	CB- <input type="checkbox"/> LC	CB- <input type="checkbox"/> LV	CB- <input type="checkbox"/> LD	CE- <input type="checkbox"/>
Power Source (Ripple 3% max.)	12-24VDC ±10%	5-12VDC ±10%		5VDC ±10%	5-12VDC ±5%
Current Consumption	50mA max.			40mA max. (20mA for S Type)	
Output	Open Collector		Voltage	Line Driver	Voltage
Output Signal	90°Quadrature + Zero Marking				
Output Phase	A,B,Z			A,B,Z,Ā,Ḃ,Ż	A,B,Z
Output Capacity	Sink Current: 35 mA max. Residual Voltage: 0.5V max.		Sink Current 20 mA max.	±20 mA	20 mA max.
Max. Applied Voltage	30V max.		-	-	-
Output Voltage	-		H: Supply Voltage -1 V min. L: 0.5 V max.	H: 2.5 V min. L: 0.5 V max.	Logic1=4-11 VDC Logic0=0.5VDC or less
Max. Freq. Response	100 kHz				60 KHz
Signal Rise/Fall Time	1µs max.			0.1µs max.	1µs max.
Insulation Resistance	-		2.2kΩ	-	2.0kΩ
Cable Length	500 +10mm				
Outside Diameter	φ5.1mm				
Weight	Approx. 120g				Approx. 100g
Shaft	φ6mm				φ4mm
Ambient Temp. : Operating	-10 - +70°C (Should not be frozen)				
Ambient Humidity:Operating	35 - 90%RH (Non-Condensing)				
Compliance	CE				

MODELS

Model	Type	Accessory	
TM-5000EK	Basic Type	TM-5000 Main Unit	ZTM051 (Reflective Tape, 10pcs.)
	Non Contact Measuring	Contact Adaptor	ZTM004-SET (Rubber Tip, 3pcs.)
TM-5010EK	Advanced Type	TM-5010E Main Unit	AAA Alkaline Battery, 4pcs. Instruction Manual
	Non Contact Measuring	Contact Adaptor	ZM4052 (Surface Speed Wheel (1/10 m) 1pc.)
TM-5000	Basic Type	TM-5000 Main Unit	ZM4053 (Surface Speed Wheel (1/10 y) 1pc.)
TM-5010E	Advanced Type	TM-5010E Main Unit	* TM-5000EK only
TM-5013	Contact Measuring	Contact Adaptor Only	ZTM004-SET (Rubber Tip, 3pcs.)
TM-5014	Contact Measuring	Contact Adaptor Only	ZM4052 (Surface Speed Wheel (1/10 m) 1pc.)



SPECIFICATIONS(Main Unit)

Model	TM - 5000	TM - 5010E
Measuring Range	6.0 - 99999.9r/min	6.0 - 99999.9 r/min 0.10 - 1666.66 r/sec 0.60 - 9999.99 m/min 1.00 - 16666.6 cm/sec 0.65 - 10936.1 y/min 0.39 - 6561.65 in/sec 1.9 - 32808.3 f/min
Resolution	0.1 r/min	0.1 r/min f/min, others 0.01
Accuracy	±0.01% ±1digit	±0.01% ±1digit (r/min m/min) ±0.05% ±1digit (Other units including conversion accuracy)
Sampling Time	1.0 - 10.0 Seconds	
Display	Measurement Display : 6digits, 7segment LCD Low-battery :mark Reflective light (☼) :mark Display Unit : /min Display Unit:/min, /sec, m/min cm/sec, y/min, in/sec, f/min Memory Display:MEM1-8, MAX, MIN	

Model	TM - 5000	TM - 5010E
Auto Power-off	After 3 minutes from last measurement or key operation	
Data Hold Time	Measurement Data : until the next data is defined - Memory Data : same as battery life	
Measuring Method	Non-contact Measurement : Using Main Unit or with remote sensor (with Reflective Tape) Contact Measurement : Using Contact Adaptor (with Rubber Tip or Surface Speed Wheel)	
Optical System	Operating Range : 50 - 300mm, ±40°degrees	
Power Supply	AAA Alkaline Battery, 4pcs.	
Battery Life with Continuous Measurement	Approx.20 Hours	
Ambient Temp. : Operating	5 - +40°C (Should not be frozen)	
Ambient Humidity:Operating	35 - 85%RH (Non-Condensing)	
Ambient Temp. : Storage	-10 - +60°C (Should not be frozen)	
Dimension/Weight (Battery Included)	122mm(H) x 58mm(W) x 28mm(D) Approx. 130g	
Compliance	CE, RoHS	

FUNCTIONS

TM-5000 **TM-5010E**

TM-4015

The remote sensor can be used by turning the slide switch inside the battery box located at the back of this unit.

ZTM004

ZTM052/53

Contact Adaptor (Rotating shaft)

OPTION

- ZTM051** Reflective Tape, 10pcs.
- ZTM004-SET** Rubber Tip, 3pcs.
- ZM4052** Surface Speed Wheel (1/10 m), 1 pc.
- ZM4053** Surface Speed Wheel (1/10 y), 1 pc.
- TM-4015** Remote sensor (21mm diameter, maximum cable length 1m)

<ul style="list-style-type: none"> ① Photoelectric Part ② Displays and Indicators ②a Photoelectric Detector Indicator ②b Unit Display ②c Memory Number Display 	<ul style="list-style-type: none"> ②d Measurement Display ③ Measurement Button ④ Remote Sensor Probe ④a Connector For Remote Sensor Probe 	<ul style="list-style-type: none"> ⑤ Key Switches ⑤a Measurement Mode Switch ⑤b 8-Point Memory Data Input Key ⑤c 8-Point Memory Data Read/Clear Key ⑤d Unit Selection Key 	<ul style="list-style-type: none"> ⑤e Rotational / Linear Speed Units Group Selection Key ⑥ Contact Adaptor ⑥a Rubber Tip ⑥b Surface Speed Wheel
---	---	--	--

MODELS

Model	Type	Accessory
TM-7000K2	Basic Laser Type	TM-7000 Main Unit
	Non Contact Measuring Contact Measuring (Use Adaptor)	Contact Adaptor
TM-7010EK	Advanced Laser Type	TM-7010E Main Unit
	Non Contact Measuring Contact Measuring (Use Adaptor)	Contact Adaptor
TM-7020K2	Contact type	TM-7020 Main Unit
	Contact Measuring Only	Contact Adaptor



SPECIFICATIONS(Main Unit)

Model	TM - 7000	TM - 7010E	TM-7020	Model	TM - 7000	TM - 7010E	TM-7020
Measuring Range (Non Contact)	6.0 - 99999.9r/min	6.0 - 99999.9 r/min	Prescale	Auto Power-off	After 3 minutes from last measurement or key operation		
Measuring Range (TM-7000/7010/7010E with Contact Adaptor)	6.0 - 15000.0r/min	0.10 - 1666.66 r/sec	Mode	Data Hold	Measurement Data : until the next data is defined		
		0.10 - 250.00 r/sec	1.0 - 6000.0r/min	Time	-	Memory Data : same as battery life	-
Resolution	0.1 r/min	6.0 - 15000.0 r/min	0.1 -	Measuring Method	Non-contact Measurement : Using Main Unit (with Reflective Tape)		Contact Type Measurement : Using Main Unit (with Rubber Tip or Surface Speed Wheel)
		0.10 - 250.00 r/sec	99999.9/min		Contact Type Measurement : Using Contact Adaptor (with Rubber Tip or Surface Speed Wheel)		
Accuracy	±0.01% ±1digit	0.60 - 1500.00 m/min	0.01 -	Optical System (Except TM-7020)	Light Source : Laser, Class 2		
		1.00 - 2500.00 cm/sec	99999.9/min		Operating Range : 50 - 1000mm, ±40°degrees		
Sampling Time	1.0 - 10.0 Seconds (1.0 - 2.0 Seconds, with Contact Adaptor)	0.65 - 1640.41 y/min	0.01 -	Wavelength : 650 nm , CW			
		0.39 - 984.25 in/sec	9999.99/sec	Power Output : Max. 1 mW			
Display	Measurement Display : 6digits, 7segment LCD Low-battery : :mark On Target (:mark	1.9 - 4921.25 f/min	9999.99/sec	Power Supply	AAA Alkaline Battery, 4pcs.		
		Display Unit : /min			Battery Life with Continuous Measurement	Approx. 30 Hours	Approx. 15 Hours
Prescale Range	-	0.001 - 999.999		Backlight		Blue (Auto-Backlight Off after 10 seconds of inactivity)	
		Memory Display:MEM1-25, MAX, MIN Prescale Mode Indicator :PS			Ambient Temp./Humidity: Operating	5 - +40°C (Should not be frozen) 35 - 85%RH (Non-Condensing)	
Compliance	-	-		Ambient Temp. : Storage		-10 - +60°C (Should be not frozen)	
		-			Dimension/Weight (Battery Included)	TM-7000 / TM-7010 : 125mm(H) x 58mm(W) x 27.4mm(D) / Approx. 140g	
-		-		TM-7020 : 144mm(H) x 58mm(W) x 36mm(D) / Approx. 170g			

FUNCTIONS

TM-7000 (Laser)

TM-7010E (Laser)

TM-7020 (Rotating shaft)

Contact Adaptor (Rotating shaft)

ZTM004 ZTM052/53

OPTION

- ZTM051** Reflective Tape, 10pcs.
- ZTM004-SET** Rubber Tip, 3pcs.
- ZM4052** Surface Speed Wheel (1/10 m), 1 pc.
- ZM4053** Surface Speed Wheel (1/10 y), 1 pc.

Image for illustrative purposes only

① Photoelectric Part	②d Low-battery Indicator	③ Measurement Button	④a Linear/Surface Speed Key (Unit Selection Key)	⑤ Contact Adaptor
② Displays and Indicators	②a Contact Measurement Indicator	④ Key Switches	④b Rotational Speed Key (Unit Selection Key)	⑤a Rubber Tip
②a Measurement Display	②f Memory Number & MAX-MIN Display	④a Enter Key	④c Clear Key	⑤b Surface Speed Wheel
②b Prescale Setting Indicator	②g Laser On Indicator	④b Memory Call Key		
②c Unit Display	②h On Target Indicator	④c Clear Key		

MODELS

TC-250 (Basic type)

- 1.Auto Power-off
- 2.Data Hold



TC-400 (Advanced type)

TC-330WP (Water Proof type)

- 1.°C / °F(Selectable)
- 2.Auto Power-off
- 3.Data Hold
- 4.Data Record (MAX / MIN / Memory)
- 5.Relative Measurement

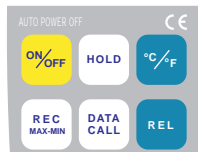

SPECIFICATIONS

Model	TC-250	TC-400 / TC-330WP
Sensor Type	Type K (TC-330WP is Water Proof Probe Only)	
Measuring Range	-160°C (-256°F) - +1,372°C(+ 2,502°F)	
Resolution	Automatic +199.9°C(+391.8°F) or less : 0.1°C (0.2°F) +200°C(+392°F) or more : 1°C (1°F)	
Accuracy at Ambient Temp. 25°C(77°F)±5°C(41°F)	0 °C (32°F) - 199.9 °C (391.8°F) ±: 0.1 % of reading +0.7 °C(1.3°F) -0.1°C (31.8°F) or less, +200 °C(+392°F) or more : ±0.2% of reading +1°C (1.8°F)	
Temperature Coefficient	±0.015% of reading + 0.06°C(0.108°F) / °C(1.8°F)	
Sampling Time	Approx. 1.2 sec.	
Operation Function	Auto Power-off, Data Hold	°C / °F(Selectable), Auto Power-Off, Data Hold, Data Record(MAX / MIN / Memory), Relative Measurement
Ambient Temp./Humidity: Operating	0 - 50°C (Should not be frozen) 0 - 90%RH at 0 - 35°C (Non-Condensing)	
Power Supply	Battery 006P (9V)	
Battery life	Approx. 500 Hours	
Size	166mm(H) x 68mm(W) x 35mm(D)	
Weight (Batt. included)	TC-250 / TC-400 : Approx. 200g / TC-330WP : Approx. 210g	
Sensor Connector	Thermocouple Connector / Water Proof Connector	
Accessories	Instruction Manual, Battery 006P, 1pc.	
Compliance	CE, RoHS	

Probe for TC-250 / TC-400

Model	Max. Temp.	Applications / Type
KF-01A	500°C (932°F)	Surfaces
KF-02A	500°C (932°F)	Surfaces / Hard-to-reach Surfaces
KS-21A	800°C (1,472°F)	Interiors of Semi-solids (with High Temperature) Pipe type : SUS316

Probe for TC-330WP

Model	Max. Temp.	Tip Shape / Material
KB-101WP	300°C(572°F)	Slanted / SUS304
KB-102WP	300°C(572°F)	Slanted / SUS304
KB-103WP	600°C(1,112°F)	Pointed / SUS304
KB-104WP	700°C(1,292°F)	Spherical / SUS316
KB-105WP	800°C(1,472°F)	Pointed / SUS316

Cable : 1,000mm

DIMENSIONS : mm

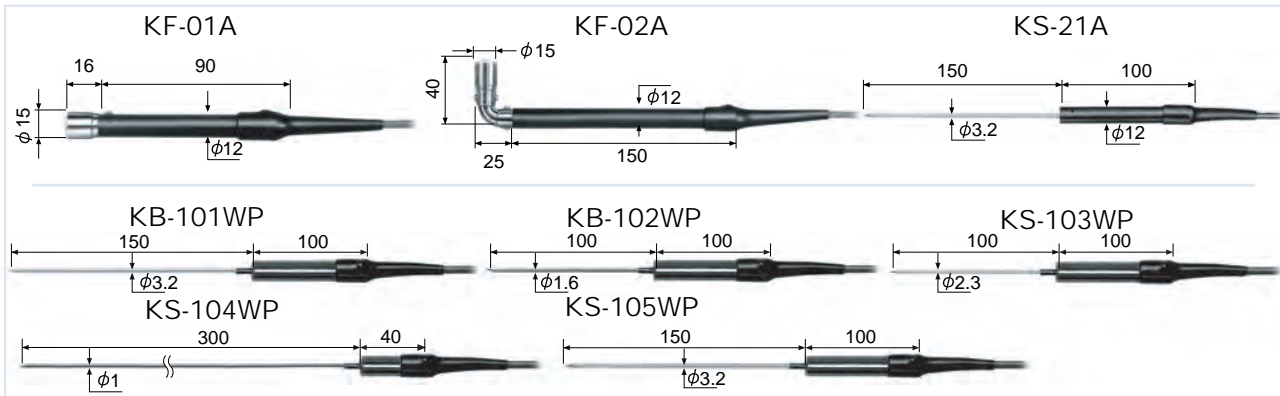

MODELS : TC-6000



- Simple & Easy Operation Infrared Thermometer.
- Handy gun type with laser marking function.
- EL back light function.
- In Conformance to CE(EMC).

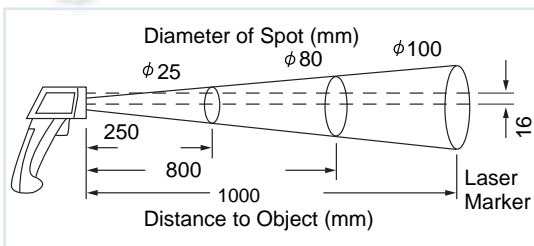

SPECIFICATIONS

Measuring Range	- 30°C - +550°C
Resolution	0.5°C/1°C Automatic Change
Accuracy	±2% rdg or ±3°C whichever is higher
Sampling Time	4 times / sec
Emittance	0.95 Fix
Measuring Area Size	φ100 - 1000mm
Ambient Temp./Humidity: Operating	0 - 50°C / 0 - 70%RH *
Ambient Temp./Humidity: Storage	-20 - +60°C / 0 - 80%RH *
Display	3.5 Digit LCD Display
Power Supply	9V 006P
Size/Weight(Batt. included)	148(H) x 105(W) x 42(D)mm / Approx. 160g
Accessories	One Battery 006P, Instruction Manual, Plastic Cover
Compliance	CE, RoHS

* Should not be frozen, Non-Condensing

MODELS : EM-1000



SPECIFICATIONS : EM-1000

Display	8mm LCD
Measurement	Anemometer, Humidity, Temperature, Light, Air flow (CFM / CMM).
Ambient Temp. : Operating	0 - +50°C (32 - 122°F) *
Ambient Humid. : Operating	Max. 80%RH *
Over Input Display	Indication of "- - - -"
Power Supply	006P DC 9V battery (Heavy duty type)
Power Consumption	Approx. DC 6.2 mA
Dimension / Weight (Battery Included)	156mm(H) x 60mm(W) x 33mm(D) / Approx. 160g
Compliance	CE, RoHS

* Should not be frozen, Non-Condensing

MODELS : EA/EH/EL-1000



SPECIFICATIONS : EA/EH/EL-1000

Models	EA-1000	EH-1000	EL-1000
Display	13mm LCD	12.5mm LCD	13mm LCD
Measurement	Anemometer	pH Meter	Light Meter
Sensor	Vane Method	glass electrode method	Silicon Photo Diode
Measurement Range	m/s:0.8-30.0m/s km/h:2.8-108km/h	pH1.00-pH13.00	A:0-1999LUX B:2000-19990LUX
Resolution	m/s:0.1m/s km/h:0.1km/h	pH0.01	A:1LUX B:10LUX
Accuracy	±(3%+2d)	pH5-pH9:±0.07 pH4-pH4.9/pH9.1-pH10:±0.1 pH1-pH3.9/pH10.1-pH13:±0.2	±(5%+4d)
Sampling Time	Approx. 0.4 sec.		-
Power Source	006P DC 9V battery (Heavy duty type)		
Battery life	270 Hours		
Dimension	Main Unit:131x70x25mm		
Weight (Batt. included)	Sensor Head: φ72x31mm	Sensor: φ9.5x120mm	Sensor:82x55x7mm
Accessories	Approx.270g		
Ambient Temp. : Operating	Approx.200g		
Ambient Humid. : Operating	Manual, Battery		
	0 - +50°C *		
	Max. 80%RH *		

* Should not be frozen, Non-Condensing

MODELS : HT-7000



SPECIFICATIONS : HT-7000

Display	13mm LCD
Measurement	Clamp Meter
Sensor	Hall Effect Sensor
Measurement Range	DC Voltage 200mV : 0-400VAC/DC 200V: 0-600VAC/DC 600V: 0-600VAC/DC AC Voltage 200V: 0-600VAC/DC 600V: 0-600VAC/DC resistance 2000 : 0-400VAC/DC AC/DC Current 200A: 0-1000AAC/DC 1000A: 0-1000AAC/DC
Resolution	DC Voltage 200mV:0.1mV 200V:0.1V 600V:1V AC Voltage 200V:0.1V 600V:1V resistance 2000 :1 AC/DC Current 200A:0.1A 1000A:1A
Accuracy	DC Voltage 200mV: ±(1%+1d) 200V: ±(1%+1d) 600V: ±(1%+1d) AC Voltage 200V: ±(1%+2d) 600V: ±(1%+2d) resistance 2000 : (1%+1d) AC/DC Current 200A: ±(1.5%+15d) 1000A: ±(2%+5d)
Sampling Time	Approx. 0.4 sec.
Power Source	006P DC 9V battery (Heavy duty type)
Battery life	50 Hours
Dimension	230 x 70 x 36mm (Clamp : 34mm in diameter)
Weight(Batt. included)	Approx. 400g
Accessories	Test Leads (red and black)x1, Manual, Battery
Ambient Temp. : Operating	0 - +50°C *
Ambient Humid. : Operating	Max. 80%RH *

* Should not be frozen, Non-Condensing

MODELS



Models	DK-100H / DK-100D / DK-100M		DK-2300	DK-4500
Display	7 Segment LCD			
Digit Size (H)	10mm		Main : 10mm Sub : 5mm	5mm
No. of Digits	4		Main : 4.5 Sub : 5	Counter Display : 4 Internal : 5
Count Range	0-9999		Main : -9999 - +19999 Sub : -9999 - +9999	Counter Display : 0-9999 Internal : 0-99999
Power Source	DK-100H:CR2032	DK-100M/100D:CR1632	CR2032	AAA alkaline battery x 4
Battery Life (Approx.)	DK-100H:2.5 Years	DK-100M/100D:1 Years	1.5 Years	200 Hours
Dimensions	DK-100H:42x65.5x18.4mm	DK-100M/100D:42.1x60x25.5mm	50.8 x 77.8 x 18.5mm	140 x 62 x 21mm
Weight (batt. included)	DK-100H:Approx. 30g	DK-100M/100D:Approx. 25g	Approx. 40g	Approx. 130g
Ambient Temp. : Operating	5 - 40°C			-10 - +50°C
Ambient Humid. : Operating	85%RH			
Storage Temp.	-10 - +60°C			
Accessories	500mm length lanyard(DK-100H/DK-2300 Only), Battery, Instruction Manual, Sticker x 5 (DK-4500 Only)			
Others	DK-100H:Hand Held Tally	DK-100M/100D:Desk Tally DK-100M:Master Unit	4 Function Tally Counter	5 in 1 Tally Counter PC Serial Communication

DK-100M Function

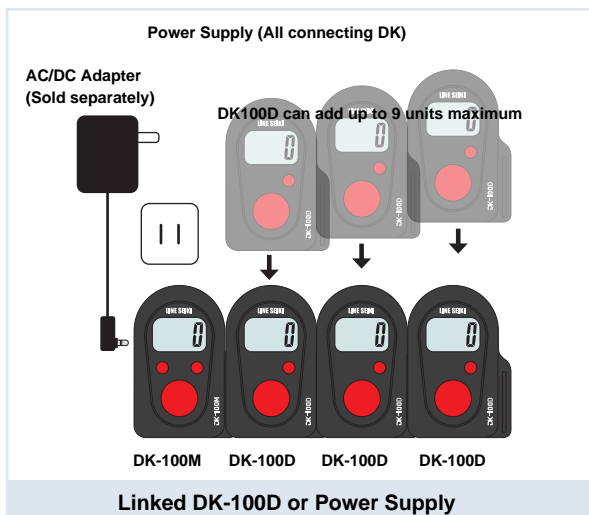

DK-4500 Operation

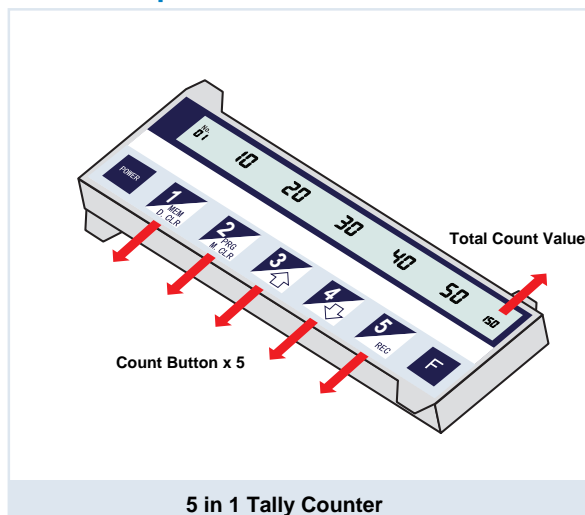

DK-2300 Function

DK-2300

To change from one type to another, remove the battery first before changing the DIP Switch setting.

TYPES	Switch 1	Switch 2
Type 1 Up/Down Counter	ON	ON
Type 2 2 Counter Tally	ON	OFF
Type 3 3 Up/Down Counters	OFF	ON
Type 4 Counter with Memory	OFF	OFF

4 Function Tally Counter

DK-4500 Function

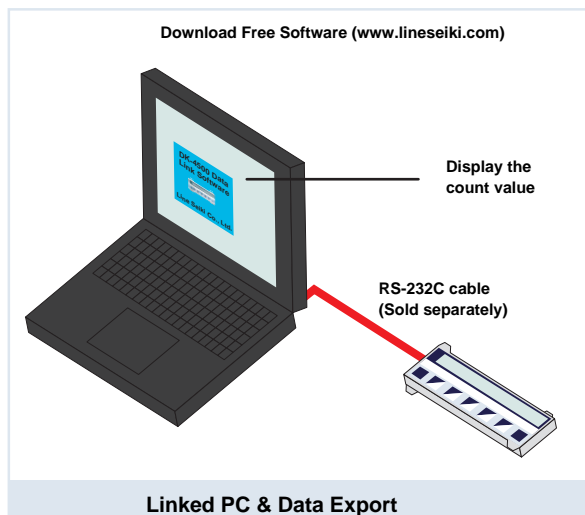



www.lineseiki.com



Line Seiki Co., Ltd.

Line Seiki Co., Ltd. - Head Office
37-7 Chuo-cho, 2-Chome
Meguro-ku, Tokyo JAPAN 152-0001
Tel: +81-3-37165151
Fax: +81-3-37104552
E-mail: webtrade@line.co.jp